



Overview: model class **Q-CLASSIC-90**

Safe and approved storage of flammable hazardous substances in working areas



Robust industrial talent

- extremely robust design with scratch-proof surface
- triple hinged door for extreme strain
- safety elements assembled outside the storage compartment for increased protection against corrosion



High flexibility

- integrated transport base for simple inhouse transport
- cabinet can be transported upright through doors (all Q-LINE models)
- adjustable feet installed in the base allow the safe and fast compensation of minor surface unevenness



Guarantee up to 10 years

- the quality of Q convinces. That's why we give you a manufacturer's guarantee of up to 10 years

Further features of this model class

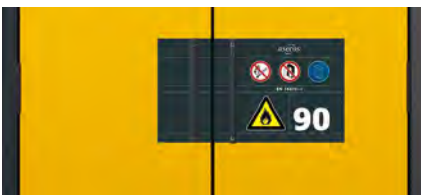

Modern bicolour design

- the Q-CLASSIC brings colour to your workplace: choice of seven door colours at no extra cost
- language-free labelling for optimum international usability



Cylinder lock with locking status indicator

- doors lockable with cylinder lock; the cabinets can be integrated by the customer in an existing master key system
- locking status indicator (red/green) signals the locking status of the cabinet



Visual inspection of the exhaust air function

- integrated air ducts ready for connection (DN 75) to a technical exhaust system
- visual inspection of the exhaust air function in the exhaust grille (rotating fan impeller)

Possible interior equipment



- **metal-free interior equipment** for the storage of aggressive hazardous materials
- as standard with **removable plastic sump**



- **drawers** with high storage volumes, ideal for storing small containers



- **height-adjustable shelves** in different versions



- **bottom collecting sump** – safe collection of leakages
- usable as storage level in conjunction with perforated insert



Safety storage cabinets for unrestricted storage of flammable hazardous materials in work areas in accordance with EN 14470-1 and TRGS 510



CLASSIC



- **fire resistance of 90 minutes** (type 90), type-tested in accordance with EN 14470-1



- **GS-tested** (EN 14470-1, EN 14727, document EK5/AK4 09-10, ProdSG)
- **50,000** wear-free opening and closing actions
- test basis: all cabinets of this model group correspond to the requirements of the Equipment and Product Safety Act (§7 Para. 1) with respect to the guarantee of safety and health



- all cabinets of this model group have been successfully tested in accordance with **FM test standard 6050** and are compliant to NFPA Code 30, NFPA 1 Fire Code, OSHA



- **excellent products with special manufacturer warranty**
- extended **manufacturer warranty of up to ten years** in connection with the asecos PREMIUM Q tariff



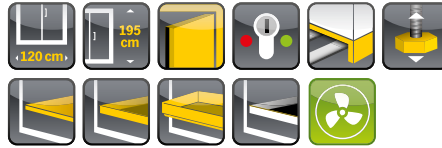

Safe and approved storage of flammable hazardous substances in working areas

Function / construction:

- **robust construction and longevity:** triple hinged door, safety elements assembled outside the storage compartment for increased protection against corrosion, scratch- and impact-resistant surface, easy to clean
- **easy handling with comfort:** doors stop in any position, self-closing in the event of fire
- **no unauthorised use:** doors lockable with cylinder locking (integration in an existing locking system possible) and locking state indicator (red/green)
- **easy transport:** integrated transport base with removable, optional base cover
- **easy alignment:** adjusting aids to compensate for uneven floor

- **ventilation:** integrated air ducts ready for connection (DN 75) to a technical exhaust system, spinning wheel in the exhaust grid as an indicator of sufficient technical ventilation

Available equipment

- shelves with load capacity of 75 kg
- tray shelves with load capacity of 150 kg
- perforated insert useable as storage area
- bottom collecting sump
- drawers – high storage capacity, optimal use of the available storage capacities
- drawers heavy-duty with load capacity of 100 kg
- metal-free tray shelves and collecting sumps
- storage box
- sump inliner (PE or PP)

Safety storage cabinet

Q-CLASSIC-90 model Q90.195.120

Body colour Anthracite grey (RAL 7016), with wing doors in Warning yellow (RAL 1004), interior equipment with 3 x shelf, 1 x perforated insert, 1 x bottom collecting sump (sheet steel powder-coated)

Order No. 30001-040-33635

(base cover and recirculating air filter system optional)



Maximum flexibility
No problem with the Q-CLASSIC-90 including transport base and

- technical ventilation with recirculating air filter system (optional)
- Q-Mover (optional) for in-house transport



Shelf
Height adjustable (32 mm increments), with 30 mm upstand



SUCCESSFULLY TESTED IN ACCORDANCE WITH FM TEST STANDARD 6050



Extraction unit
Safe ventilation of safety storage cabinets
plug-in – fast and easy to install

Further information and products from page 397

Order No. 14218



Recirculating air filter system
Avoid complex wall breakthroughs and expensive extraction piping

Further information from page 393

Order No. 25099



Safety storage cabinet

Q-CLASSIC-90 model Q90.195.120

Body colour Anthracite grey (RAL 7016), with wing doors in Traffic red (RAL 3020), interior equipment with 6 x drawer (sheet steel powder-coated)

Order No. 30001-046-33649

(base cover and recirculating air filter system optional)

Safety storage cabinet

Q-CLASSIC-90 model Q90.195.120

Body colour Anthracite grey (RAL 7016), with wing doors in Light grey (RAL 7035), interior equipment with 4 x drawer (sheet steel powder-coated)

Order No. 30001-041-33647

(base cover optional)

7 door colours are available **at no extra cost:**



Order example - how to order correctly



Model	Information / equipment	Order No.
Q90.195.120	without interior equipment	30001

Body colour	Door colour	Order No.
Anthracite grey RAL 7016	Warning yellow RAL 1004	040
Anthracite grey RAL 7016	Light grey RAL 7035	041
Anthracite grey RAL 7016	Traffic red RAL 3020	046
Anthracite grey RAL 7016	Gentian blue RAL 5010	047
Anthracite grey RAL 7016	Reseda green RAL 6011	048
Anthracite grey RAL 7016	asecos silver	049
Anthracite grey RAL 7016	Pure white RAL 9010	050

Interior equipment packages (can only be ordered in combination with the cabinet)	Material	Order No.
		old code new code
3x shelf, 1x perforated insert, 1x bottom collecting sump (V=33.0L)	sheet steel powder-coated RAL 7035	30003 33635
4x shelf, 1x perforated insert, 1x bottom collecting sump (V=33.0L)	sheet steel powder-coated RAL 7035	30004 33636
3x shelf, 1x bottom collecting sump (V=33.0L)	sheet steel powder-coated RAL 7035	30005 33637
4x shelf, 1x bottom collecting sump (V=33.0L)	sheet steel powder-coated RAL 7035	30006 33638
3x tray shelf (V=33.0L), 1x perforated insert, 1x bottom collecting sump (V=55.5L)	sheet steel powder-coated RAL 7035	30007 33640
3x shelf, 1x perforated insert, 1x bottom collecting sump (V=33.0L)	stainless steel	30008 33642
4x shelf, 1x perforated insert, 1x bottom collecting sump (V=33.0L)	stainless steel	30009 33643
3x shelf, 1x bottom collecting sump (V=33.0L)	stainless steel	30010 33644
4x shelf, 1x bottom collecting sump (V=33.0L)	stainless steel	30011 33645
3x tray shelf (V=33.0L), 1x bottom collecting sump (V=33.0L)	PP grey	HIGHLIGHT 30013 30013
4x tray shelf (V=33.0L), 1x bottom collecting sump (V=33.0L)	PP grey	HIGHLIGHT 30014 30014
4x drawer (V=30.0L)	sheet steel powder-coated RAL 7035	30015 33647
5x drawer (V=30.0L)	sheet steel powder-coated RAL 7035	30016 33648
6x drawer (V=30.0L)	sheet steel powder-coated RAL 7035	30017 33649
4x drawer (V=30.0L)	stainless steel	30018 33651
5x drawer (V=30.0L)	stainless steel	30019 33652
6x drawer (V=30.0L)	stainless steel	30020 33653



Individual configuration of model Q90.195.120

Model	Information / equipment	W x D x H (mm)	Order No.
Q90.195.120	without interior equipment	1193 x 615 x 1953	30001

Body colour	Door colour	Order No.
Anthracite grey RAL 7016	Warning yellow RAL 1004	040
Anthracite grey RAL 7016	Light grey RAL 7035	041
Anthracite grey RAL 7016	Traffic red RAL 3020	046
Anthracite grey RAL 7016	Gentian blue RAL 5010	047
Anthracite grey RAL 7016	Reseda green RAL 6011	048
Anthracite grey RAL 7016	asecos silver	049
Anthracite grey RAL 7016	Pure white RAL 9010	050

Interior equipment	Material	W x D x H (mm)	1)	2)	3)	Order No.	
						old code	new code
shelf	sheet steel powder-coated RAL 7035	1040 x 432 x 30*	75.00			30021	30021
	stainless steel	1038 x 425 x 29*	75.00			30024	30024
tray shelf	sheet steel powder-coated RAL 7035	1025 x 445 x 71*	150.00	33.00	30.00	30028	30028
	stainless steel	1025 x 445 x 71*	150.00	33.00	30.00	30064	30064
tray shelf, metal-free	PP grey	1002 x 472 x 74*	50.00	33.00	30.00	30027	30027
perforated insert	sheet steel powder-coated RAL 7035	1024 x 417 x 60	75.00			5536	5536
	stainless steel	1024 x 417 x 60	75.00			5773	5773
perforated insert, height = 135 mm	sheet steel powder-coated RAL 7035	1024 x 417 x 135	135.00			14084	14084
bottom collecting sump	sheet steel powder-coated RAL 7035	1024 x 489 x 86*		33.00	30.00	30022	33634
	stainless steel	1024 x 489 x 86*	150.00	33.00	30.00	30025	33641
bottom collecting sump, V = 55,5 ltr.	sheet steel powder-coated RAL 7035	1017 x 482 x 127*		55.50	50.45	30023	33639
	stainless steel	1018 x 438 x 120*		55.50	50.00	30026	30026
bottom collecting sump, metal-free	PP grey	1002 x 472 x 74*		33.00	30.00	26989	26989
drawer	sheet steel powder-coated RAL 7035	844 x 488 x 90*	60.00	30.00	2727	30013	33646
	stainless steel	844 x 488 x 90*	60.00	30.00	2727	30033	33650
drawer (heavy-duty)	sheet steel powder-coated RAL 7035	843 x 487 x 162*	100.00	66.00		30032	30032
	stainless steel	843 x 487 x 162*	100.00	66.00		30034	30034
storage box, left hinged	sheet steel powder-coated RAL 7035	380 x 420 x 360				30029	30029
storage box, right hinged	sheet steel powder-coated RAL 7035	380 x 420 x 360				30030	30030
sump inliner, for shelf	polyethylene black	1000 x 392 x 50*				7223	7223
sump inliner, for drawer	PP grey	834 x 450 x 96*				10054	10054
anti-slip rubber mat, for drawer	black	840 x 490 x 1				8699	8699
pipe lead-through	sheet steel powder-coated RAL 7035	182 x 104 x 48				30035	30035
base cover	sheet steel powder-coated textured RAL 7016	1118 x 35 x 85				30036	30036
Q-mover, 2 pieces	steel powder-coated textured RAL 7016	600 x 140 x 130	450.00			30037	30037
box for chemicals	PP blue	410 x 300 x 260		18.00	16.36	30038	30038
document holder, DIN A5	polystyrene					30793	30793

Accessories	Order No.
recirculating air filter system with exhaust air monitoring	25099
extraction unit without exhaust air monitoring	14218

* usable storage space W x D [mm]
 1) load capacity [kg], 2) retention capacity [ltr], 3) maximum container volume in the cabinet [ltr]



**NEWS and
LATEST INFORMATION:**
www.asecos.com

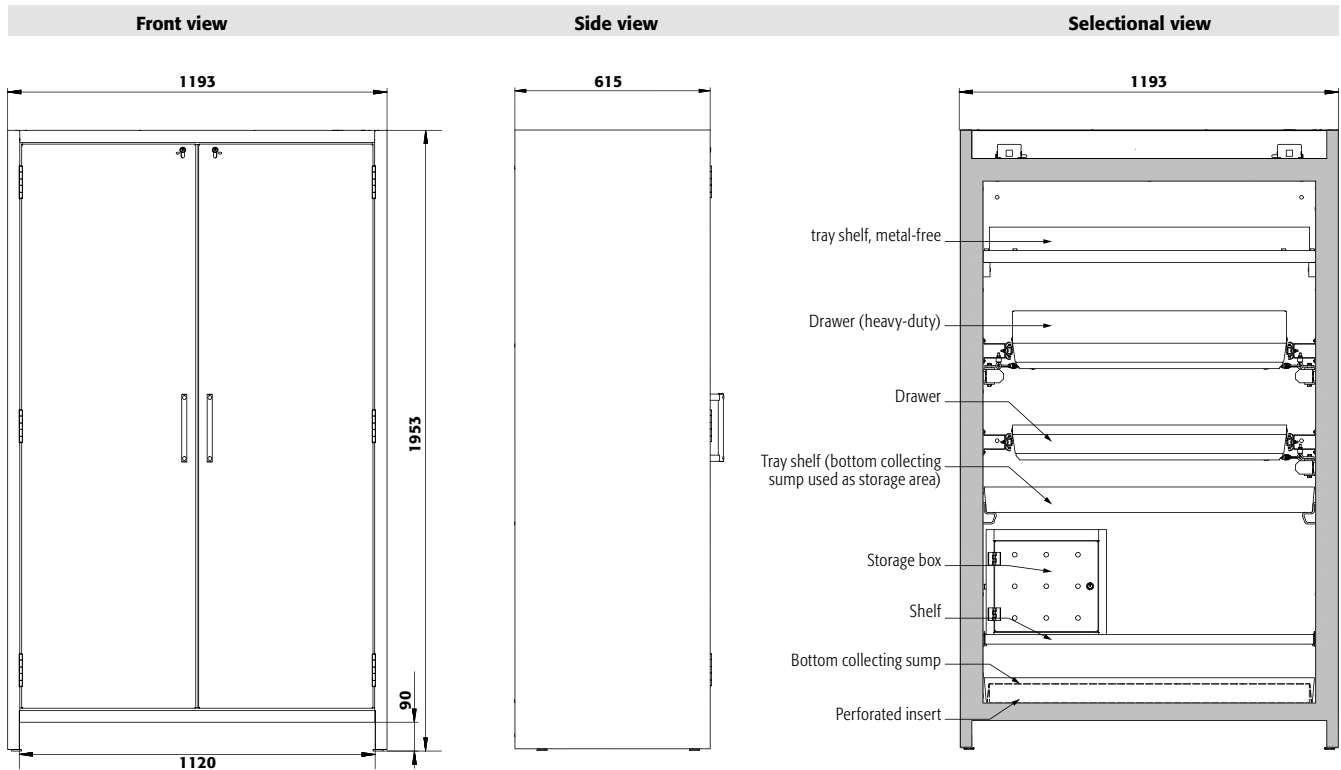

Technical data

Q90.195.120

External dimensions W x D x H	mm	1193 x 615 x 1953
Internal dimensions W x D x H	mm	1050 x 522 x 1647
Weight without interior equip.	kg	424
Air change 10 times	m ³ /h	9
Diff. pressure (air change 10 times)	Pa	5
Diff. pressure (air change 10 times EK5/AK4)	Pa	5
Maximum load	kg	600
Distributed load	kg/m ²	531

Transport base

Entry height transport base	mm	90
Entry width transport base	mm	1120

Top view

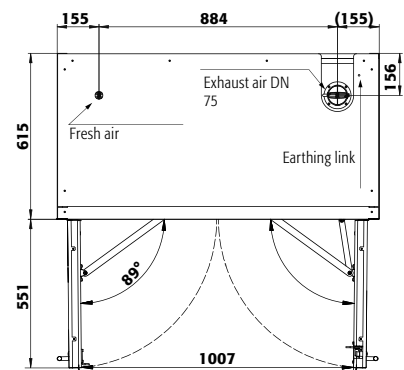

Q90.195.120

Drawers/number

	9	8	7	6	5	4+1	4	3	2
Distance ⑨ (mm)	150								
Distance ⑧ (mm)	135	150							
Distance ⑦ (mm)	135	170	185						
Distance ⑥ (mm)	135	170	200	250					
Distance ⑤ (mm)	135	170	200	230	250	250			
Distance ④ (mm)	135	170	200	230	295	230	345		
Distance ③ (mm)	135	170	200	230	295	230	360	440	
Distance ② (mm)	170	170	200	230	295	230	360	520	890
Distance ① (mm)	200	200	200	230	295	490	390	520	615

Standard storage heights of the drawers

Q90.195.120

Shelves/number

	4	3
Distance ④ (mm)	320	
Distance ③ (mm)	350	420
Distance ② (mm)	350	450
Distance ① (mm)	290	380

Standard storage heights of the shelves

Q90.195.120

Quantity

Quantity	Type of container	Container size
90	Aerosol cans	400 ml
40	Cans	1 litre
40	Laboratory glass bottles	1 litre
40	Laboratory PE-bottles	1 litre
15	Laboratory glass bottles	2.5 litres

Storage capacities per drawer/type of container

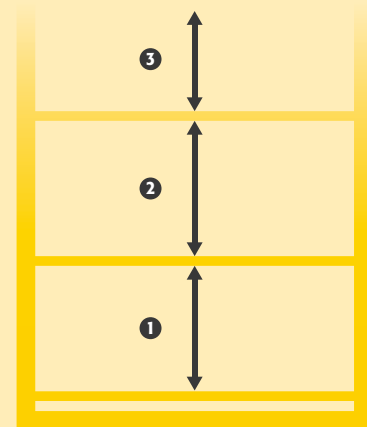



Safe and approved storage of flammable hazardous substances in working areas

Function / construction:

- **robust construction and longevity:** triple hinged door, safety elements assembled outside the storage compartment for increased protection against corrosion, scratch- and impact-resistant surface, easy to clean
- **easy handling with comfort:** doors stop in any position, self-closing in the event of fire
- **no unauthorised use:** doors lockable with cylinder locking (integration in an existing locking system possible) and locking state indicator (red/green)
- **easy transport:** integrated transport base with removable, optional base cover
- **easy alignment:** adjusting aids to compensate for uneven floor

- **ventilation:** integrated air ducts ready for connection (DN 75) to a technical exhaust system, spinning wheel in the exhaust grid as an indicator of sufficient technical ventilation

Available equipment

- shelves with load capacity of 75 kg
- tray shelves with load capacity of 150 kg
- perforated insert useable as storage area
- bottom collecting sump
- drawers – high storage capacity, optimal use of the available storage capacities
- drawers heavy-duty with load capacity of 100 kg
- metal-free tray shelves and collecting sumps
- storage box
- sump inliner (PE or PP)

Safety storage cabinet

Q-CLASSIC-90 model Q90.195.090

Body colour Anthracite grey (RAL 7016), with wing doors in Warning yellow (RAL 1004), interior equipment with 3 x shelf, 1 x perforated insert, 1 x bottom collecting sump (sheet steel powder-coated)

Order No. 30041-040-33622

(base cover and extraction unit optional)



Drawers

High storage capacity
Ideal for the storage of small containers



Extraction unit

Safe ventilation of safety storage cabinets

plug-in – fast and easy to install

Further information and products from page 397

Order No. 14218



Shelf

Height adjustable (32 mm increments), with 30 mm upstand



Metal-free interior equipment

Ideal for the storage of flammable, aggressive hazardous substances. Tray shelves with chemical resistant surface lamination and removeable plastic sump, bottom collecting plastic sump.



Recirculating air filter system

Avoid complex wall break-throughs and expensive extraction piping

Further information from page 393

Order No. 25099





Safety storage cabinet

Q-CLASSIC-90 model Q90.195.090

Body colour Anthracite grey (RAL 7016), with wing doors in Gentian blue (RAL 5010), interior equipment with 4 x drawer (sheet steel powder-coated)

Order No. 30041-047-33627

(base cover optional)

Safety storage cabinet

Q-CLASSIC-90 model Q90.195.090

Body colour Anthracite grey (RAL 7016), with wing doors in Light grey (RAL 7035), interior equipment with 6 x drawer (sheet steel powder-coated)

Order No. 30041-041-33629

(base cover optional)

7 door colours are available **at no extra cost:**



Order example - how to order correctly



Model	Information / equipment	Order No.
Q90.195.090	without interior equipment	30041

Body colour	Door colour	Order No.
Anthracite grey RAL 7016	Warning yellow RAL 1004	040
Anthracite grey RAL 7016	Light grey RAL 7035	041
Anthracite grey RAL 7016	Traffic red RAL 3020	046
Anthracite grey RAL 7016	Gentian blue RAL 5010	047
Anthracite grey RAL 7016	Reseda green RAL 6011	048
Anthracite grey RAL 7016	asescos silver	049
Anthracite grey RAL 7016	Pure white RAL 9010	050

Interior equipment packages (can only be ordered in combination with the cabinet)	Material	Order No.
3x shelf, 1x perforated insert, 1x bottom collecting sump (V=22.0L)	sheet steel powder-coated RAL 7035	old code 30043 new code 33622
4x shelf, 1x perforated insert, 1x bottom collecting sump (V=22.0L)	sheet steel powder-coated RAL 7035	30044 33623
3x shelf, 1x bottom collecting sump (V=22.0L)	sheet steel powder-coated RAL 7035	30045 33624
4x shelf, 1x bottom collecting sump (V=22.0L)	sheet steel powder-coated RAL 7035	30046 33625
3x shelf, 1x perforated insert, 1x bottom collecting sump (V=22.0L)	stainless steel	30047 30047
4x shelf, 1x perforated insert, 1x bottom collecting sump (V=22.0L)	stainless steel	30048 30048
3x shelf, 1x bottom collecting sump (V=22.0L)	stainless steel	30049 30049
4x shelf, 1x bottom collecting sump (V=22.0L)	stainless steel	30050 30050
3x tray shelf (V=22.0L), 1x bottom collecting sump (V=22.0L)	PP grey	HIGHLIGHT 30051 30051
4x tray shelf (V=22.0L), 1x bottom collecting sump (V=22.0L)	PP grey	HIGHLIGHT 30052 30052
4x drawer (V=19.0L)	sheet steel powder-coated RAL 7035	30053 33627
5x drawer (V=19.0L)	sheet steel powder-coated RAL 7035	30054 33628
6x drawer (V=19.0L)	sheet steel powder-coated RAL 7035	30055 33629
4x drawer (V=19.0L)	stainless steel	30056 33631
5x drawer (V=19.0L)	stainless steel	30057 33632
6x drawer (V=19.0L)	stainless steel	30058 33633



Individual configuration of model Q90.195.090

Model	Information / equipment	W x D x H (mm)	Order No.
Q90.195.090	without interior equipment	893 x 615 x 1953	30041

Body colour	Door colour	Order No.
Anthracite grey RAL 7016	Warning yellow RAL 1004	040
Anthracite grey RAL 7016	Light grey RAL 7035	041
Anthracite grey RAL 7016	Traffic red RAL 3020	046
Anthracite grey RAL 7016	Gentian blue RAL 5010	047
Anthracite grey RAL 7016	Reseda green RAL 6011	048
Anthracite grey RAL 7016	asecos silver	049
Anthracite grey RAL 7016	Pure white RAL 9010	050

Interior equipment	Material	W x D x H (mm)	1)	2)	3)	Order No.
shelf	sheet steel powder-coated RAL 7035	740 x 432 x 30*	75.00			old code 30059 new code 30059
	stainless steel	740 x 432 x 30*	75.00			30061 30061
tray shelf, metal-free	PP grey	702 x 472 x 74*	50.00	23.00	20.91	30063 30063
perforated insert	sheet steel powder-coated RAL 7035	742 x 417 x 70	75.00			11165 11165
	stainless steel	742 x 417 x 70	75.00			11168 11168
bottom collecting sump	sheet steel powder-coated RAL 7035	724 x 489 x 83*		22.00	20.00	30060 33621
	stainless steel	724 x 489 x 83*		23.00	20.91	30062 30062
bottom collecting sump, metal-free	PP grey	702 x 472 x 74*		23.00	20.91	26990 26990
drawer	sheet steel powder-coated RAL 7035	544 x 488 x 90*	60.00	19.00	1727	30065 33626
	stainless steel	544 x 488 x 90*	60.00	19.00	1727	30067 33630
drawer (heavy-duty)	sheet steel powder-coated RAL 7035	543 x 487 x 162*	100.00	45.00		30066 30066
	stainless steel	543 x 487 x 162*	100.00	45.00		30068 30068
storage box, left hinged	sheet steel powder-coated RAL 7035	380 x 420 x 360				30029 30029
storage box, right hinged	sheet steel powder-coated RAL 7035	380 x 420 x 360				30030 30030
sump inliner, for drawer	polyethylene white	536 x 480 x 90*		22.00	20.00	27948 27948
sump inliner, for shelf	PP grey	653 x 406 x 88*				9707 9707
anti-slip rubber mat, for drawer	black	540 x 490 x 1				15653 15653
pipe lead-through	sheet steel powder-coated RAL 7035	182 x 104 x 48				30035 30035
base cover	sheet steel powder-coated textured RAL 7016	818 x 35 x 85				30069 30069
Q-mover, 2 pieces	steel powder-coated textured RAL 7016	600 x 140 x 130	450.00			30037 30037
box for chemicals	PP blue	410 x 300 x 260		18.00	16.36	30038 30038
document holder, DIN A5	polystyrene					30793 30793

Accessories	Order No.
recirculating air filter system with exhaust air monitoring	25095
extraction unit without exhaust air monitoring	14218

* usable storage space W x D (mm)

1) load capacity (kg), 2) retention capacity (ltr), 3) maximum container volume in the cabinet (ltr)

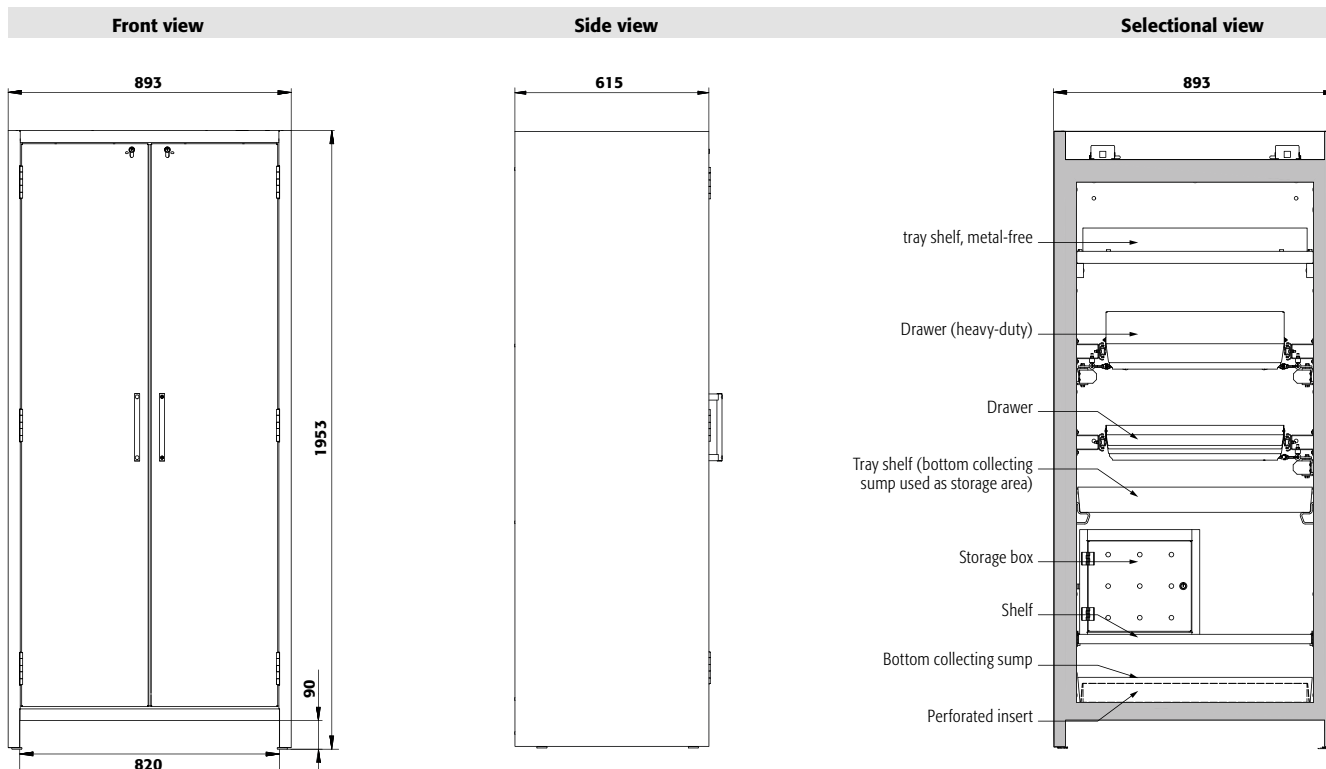

Technical data

External dimensions W x D x H	mm	893 x 615 x 1953
Internal dimensions W x D x H	mm	750 x 522 x 1647
Weight without interior equip.	kg	343
Air change 10 times	m ³ /h	6
Diff. pressure (air change 10 times)	Pa	5
Diff. pressure (air change 10 times EK5/AK4)	Pa	5
Maximum load	kg	600
Distributed load	kg/m ²	654

Transport base

Entry height transport base	mm	90
Entry width transport base	mm	820

Q90.195.090

Top view

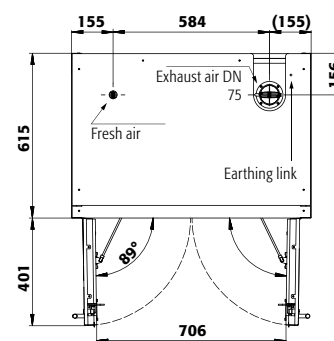

Q90.195.090

Drawers/number

	9	8	7	6	5	4+1	4	3	2
Distance ⑨ (mm)	150								
Distance ⑧ (mm)	135	150							
Distance ⑦ (mm)	135	170	185						
Distance ⑥ (mm)	135	170	200	250					
Distance ⑤ (mm)	135	170	200	230	250	250			
Distance ④ (mm)	135	170	200	230	295	230	345		
Distance ③ (mm)	135	170	200	230	295	230	360	440	
Distance ② (mm)	170	170	200	230	295	230	360	520	890
Distance ① (mm)	200	200	200	230	295	490	390	520	615

Standard storage heights of the drawers

Q90.195.090

Shelves/number

	4	3
Distance ④ (mm)	320	
Distance ③ (mm)	350	420
Distance ② (mm)	350	450
Distance ① (mm)	290	380

Standard storage heights of the shelves

Q90.195.090

Quantity

Quantity	Type of container	Container size
49	Aerosol cans	400 ml
23	Cans	1 litre
23	Laboratory glass bottles	1 litre
23	Laboratory PE-bottles	1 litre
9	Laboratory glass bottles	2.5 litres

Storage capacities per drawer/type of container

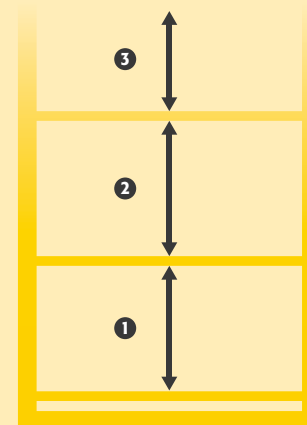



Safe and approved storage of flammable hazardous substances in working areas

Function / construction:

- **robust construction and longevity:** triple hinged door, safety elements assembled outside the storage compartment for increased protection against corrosion, scratch- and impact-resistant surface, easy to clean
- **easy handling with comfort:** door stops in any position, self-closing in the event of fire
- **no unauthorised use:** door lockable with cylinder locking (integration in an existing locking system possible) and locking state indicator (red/green)
- **easy transport:** integrated transport base with removable, optional base cover
- **easy alignment:** adjusting aids to compensate for uneven floor

- **ventilation:** integrated air ducts ready for connection (DN 75) to a technical exhaust system, spinning wheel in the exhaust grid as an indicator of sufficient technical ventilation

Available equipment

- shelves with load capacity of 75 kg
- tray shelves with load capacity of 150 kg
- perforated insert useable as storage area
- bottom collecting sump
- drawers – high storage capacity, optimal use of the available storage capacities
- drawers heavy-duty with load capacity of 100 kg
- metal-free tray shelves and collecting sumps
- storage box
- sump inliner (PE or PP)

Safety storage cabinet

Q-CLASSIC-90 model Q90.195.060

Body colour Anthracite grey (RAL 7016), with wing door in Warning yellow (RAL 1004), interior equipment with 3 x shelf, 1 x perforated insert, 1 x bottom collecting sump (sheet steel powder-coated)

Order No. 30072-040-33600

(base cover and recirculating air filter system optional)



Maximum flexibility

- No problem with the Q-CLASSIC-90 including transport base and
- technical ventilation with recirculating air filter system (optional)
- Q-Mover (optional) for in-house transport



Drawers

High storage capacity
Ideal for the storage of small containers

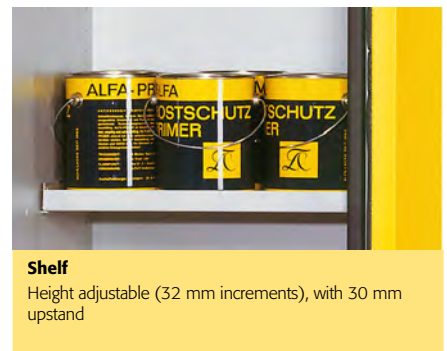

Shelf

Height adjustable (32 mm increments), with 30 mm upstand

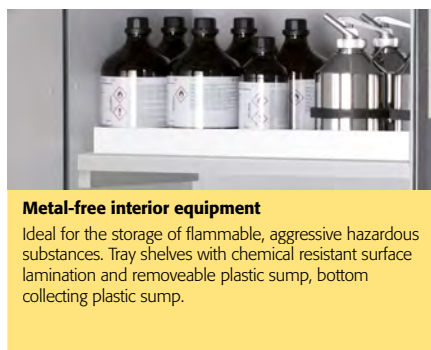

Metal-free interior equipment

Ideal for the storage of flammable, aggressive hazardous substances. Tray shelves with chemical resistant surface lamination and removeable plastic sump, bottom collecting plastic sump.





Safety storage cabinet

Q-CLASSIC-90 model Q90.195.060

Body colour Anthracite grey (RAL 7016), with wing door in Gentian blue (RAL 5010), interior equipment with 6 x drawer (sheet steel powder-coated)

Order No. 30072-047-33610

(base cover and recirculating air filter system optional)

Safety storage cabinet

Q-CLASSIC-90 model Q90.195.060

Body colour Anthracite grey (RAL 7016), with wing door in Traffic red (RAL 3020), interior equipment with 4 x drawer (sheet steel powder-coated)

Order No. 30072-046-33608

(base cover optional)

7 door colours are available **at no extra cost:**



Order example - how to order correctly



Model	Information / equipment	Order No.
Q90.195.060	without interior equipment, left hinged	30072
Q90.195.060.R	without interior equipment, right hinged	30073









Body colour	Door colour	Order No.
Anthracite grey RAL 7016	Warning yellow RAL 1004	040
Anthracite grey RAL 7016	Light grey RAL 7035	041
Anthracite grey RAL 7016	Traffic red RAL 3020	046
Anthracite grey RAL 7016	Gentian blue RAL 5010	047
Anthracite grey RAL 7016	Reseda green RAL 6011	048
Anthracite grey RAL 7016	asecos silver	049
Anthracite grey RAL 7016	Pure white RAL 9010	050

























































Interior equipment packages (can only be ordered in combination with the cabinet)	Material	Order No.
3x shelf, 1x perforated insert, 1x bottom collecting sump (V=22.0L)	sheet steel powder-coated RAL 7035	old code 30076 new code 33600
4x shelf, 1x perforated insert, 1x bottom collecting sump (V=22.0L)	sheet steel powder-coated RAL 7035	30077 33602
3x shelf, 1x bottom collecting sump (V=22.0L)	sheet steel powder-coated RAL 7035	30078 33603
4x shelf, 1x bottom collecting sump (V=22.0L)	sheet steel powder-coated RAL 7035	30079 33604
3x tray shelf (V=12.0L), 1x perforated insert, 1x bottom collecting sump (V=33.0L)	sheet steel powder-coated RAL 7035	30080 33606
3x shelf, 1x perforated insert, 1x bottom collecting sump (V=22.0L)	stainless steel	30081 30081
4x shelf, 1x perforated insert, 1x bottom collecting sump (V=22.0L)	stainless steel	30082 30082
3x shelf, 1x bottom collecting sump (V=22.0L)	stainless steel	30083 30083
4x shelf, 1x bottom collecting sump (V=22.0L)	stainless steel	30084 30084
3x tray shelf (V=12.0L), 1x perforated insert, 1x bottom collecting sump (V=33.0L)	stainless steel	30085 30085
3x tray shelf (V=11.0L), 1x bottom collecting sump (V=11.0L)	PP grey	HIGHLIGHT 30086 30086
4x tray shelf (V=11.0L), 1x bottom collecting sump (V=11.0L)	PP grey	HIGHLIGHT 30087 30087
4x drawer (V=5.0L)	sheet steel powder-coated RAL 7035	30088 33608
5x drawer (V=5.0L)	sheet steel powder-coated RAL 7035	30089 33609
6x drawer (V=5.0L)	sheet steel powder-coated RAL 7035	30090 33610
3x drawer (V=5.0L), 1x drawer (disposal) (V=30.0L)	sheet steel powder-coated RAL 7035	30091 33612
4x drawer (V=5.0L), 1x drawer (disposal) (V=30.0L)	sheet steel powder-coated RAL 7035	30092 33613
4x drawer (V=5.0L)	stainless steel	30093 33616
5x drawer (V=5.0L)	stainless steel	30094 33617
6x drawer (V=5.0L)	stainless steel	30095 33618
3x drawer (V=5.0L), 1x drawer (disposal) (V=30.0L)	stainless steel	30096 33619
4x drawer (V=5.0L), 1x drawer (disposal) (V=30.0L)	stainless steel	30097 33620



Individual configuration of model Q90.195.060

 Model	Information / equipment	W x D x H (mm)	Order No.
Q90.195.060	without interior equipment, left hinged	599 x 615 x 1953	30072
Q90.195.060.R	without interior equipment, right hinged	599 x 615 x 1953	30073

 Body colour	Door colour	Order No.
Anthracite grey RAL 7016	Warning yellow RAL 1004	040 
Anthracite grey RAL 7016	Light grey RAL 7035	041 
Anthracite grey RAL 7016	Traffic red RAL 3020	046 
Anthracite grey RAL 7016	Gentian blue RAL 5010	047 
Anthracite grey RAL 7016	Reseda green RAL 6011	048 
Anthracite grey RAL 7016	asecos silver	049 
Anthracite grey RAL 7016	Pure white RAL 9010	050 

 Interior equipment	Material	W x D x H (mm)	 ¹⁾	 ²⁾	 ³⁾	Order No.	
						old code	new code
 shelf	sheet steel powder-coated RAL 7035	440 x 432 x 30*	75.00			30098	30098 
	stainless steel	440 x 432 x 30*	75.00			30102	30102 
 tray shelf	sheet steel powder-coated RAL 7035	427 x 442 x 70*	150.00	12.00	10.91	30099	30099 
	stainless steel	427 x 442 x 70*	150.00	12.00	10.91	30103	30103 
 tray shelf, metal-free	PP grey	424 x 472 x 67*	50.00	13.00	11.82	30106	30106 
 perforated insert	sheet steel powder-coated RAL 7035	420 x 439 x 60	75.00			5555	5555 
	stainless steel	425 x 439 x 60	75.00			5776	5776 
 perforated insert, height = 180 mm	sheet steel powder-coated RAL 7035	438 x 453 x 180	75.00			17693	17693 
 perforated insert	stainless steel	438 x 453 x 170	75.00			10254	10254 
 bottom collecting sump	sheet steel powder-coated RAL 7035	442 x 507 x 127		22.00	20.00	30100	33594 
	stainless steel	418 x 433 x 120*		22.00	20.00	30104	30104 
 bottom collecting sump, height = 180 mm	sheet steel powder-coated RAL 7035	409 x 474 x 171*		33.00	30.00	30101	33605 
 bottom collecting sump, height = 170 mm	stainless steel	439 x 454 x 170*		33.00	30.00	30105	30105 
 bottom collecting sump, metal-free	PP grey	422 x 472 x 67*		12.50	11.36	25424	25424 
 drawer	sheet steel powder-coated RAL 7035	345 x 500 x 50*	25.00	5.00	4.55	30108	33607 
	stainless steel	345 x 500 x 50*	25.00	5.00	4.55	30110	33614 
 drawer (disposal)	sheet steel powder-coated RAL 7035	329 x 462 x 200*	50.00	30.00		30109	30109 
	stainless steel	329 x 462 x 150*	50.00	30.00		30111	30111 
 storage box, left hinged	sheet steel powder-coated RAL 7035	380 x 420 x 360				30029	30029 
 storage box, right hinged	sheet steel powder-coated RAL 7035	380 x 420 x 360				30030	30030 
 sump inliner, for drawer disposal	PP grey	318 x 449 x 66*				18472	18472 
 sump inliner	PP grey	353 x 406 x 88*				9706	9706 
 sump inliner, for drawer disposal	PP black	313 x 413 x 171*				18474	18474 
 anti-slip rubber mat, for drawer disposal	black	495 x 340 x 1				8719	8719 
 pipe lead-through	sheet steel powder-coated RAL 7035	182 x 104 x 48				30035	30035 
 base cover	sheet steel powder-coated textured RAL 7016	524 x 35 x 85				30112	30112 
 Q-mover, 2 pieces	steel powder-coated textured RAL 7016	600 x 140 x 130	450.00			30037	30037 
 box for chemicals	PP blue	410 x 300 x 260		18.00	16.36	30038	30038 
 document holder, DIN A5	polystyrene					30793	30793 

 Accessories	Order No.
extraction unit without exhaust air monitoring	14218 
recirculating air filter system with exhaust air monitoring	25099 

* usable storage space W x D (mm)

1) load capacity (kg), 2) retention capacity (ltr), 3) maximum container volume in the cabinet (ltr)

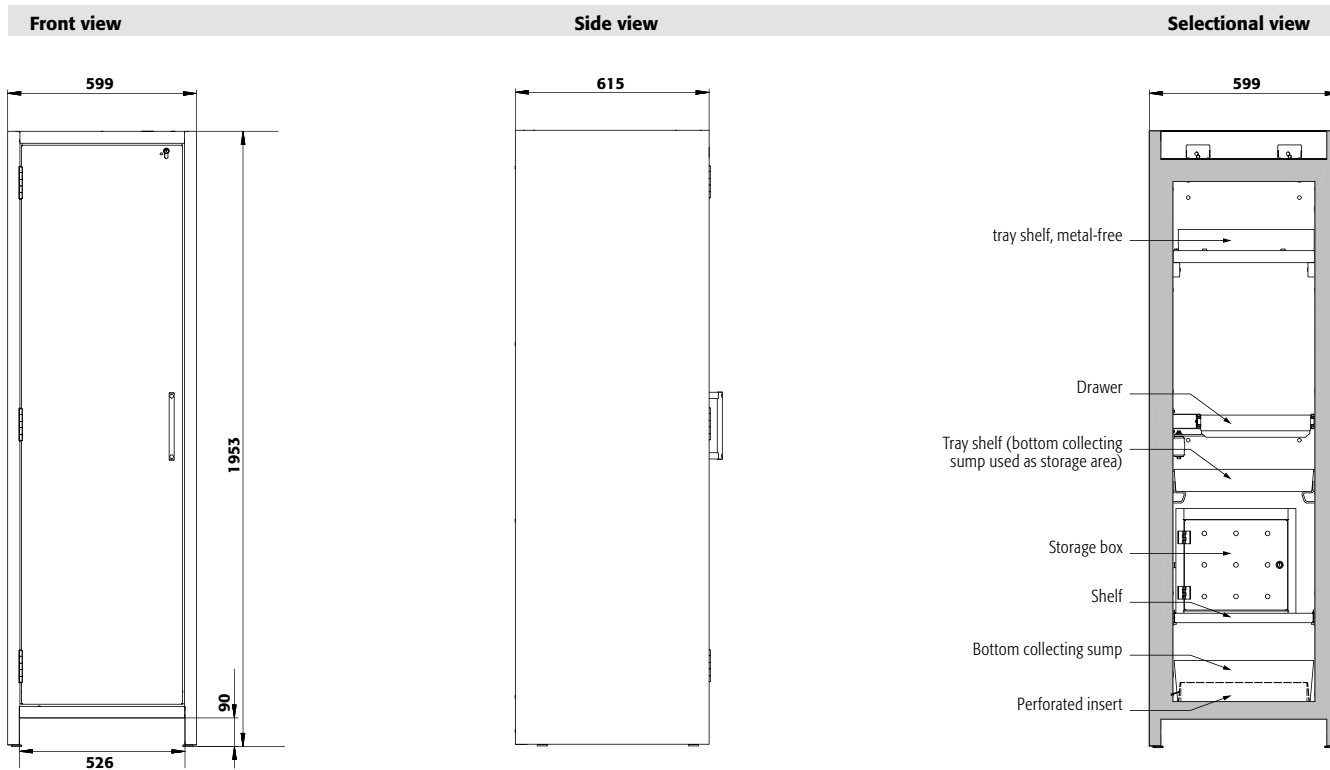

Technical data

Q90.195.060

External dimensions W x D x H	mm	599 x 615 x 1953
Internal dimensions W x D x H	mm	450 x 522 x 1647
Weight without interior equip.	kg	265
Air change 10 times	m ³ /h	4
Diff. pressure (air change 10 times)	Pa	5
Diff. pressure (air change 10 times EK5/AK4)	Pa	5
Maximum load	kg	600
Distributed load	kg/m ²	894

Transport base

Entry height transport base	mm	90
Entry width transport base	mm	526

Top view

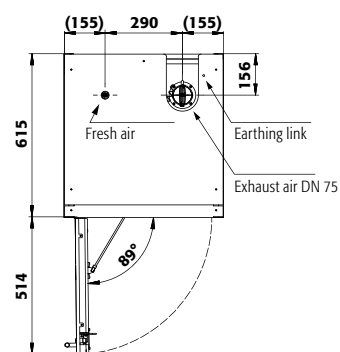

Q90.195.060

Drawers/number

	Standard storage heights of the drawers										
	9	8	7	6	5	4+1	4	3+1	3	2	
Distance ⑨ (mm)	145										
Distance ⑧ (mm)	135	145									
Distance ⑦ (mm)	135	170	180								
Distance ⑥ (mm)	135	170	200	240							
Distance ⑤ (mm)	135	170	200	230	240	145					
Distance ④ (mm)	135	170	200	230	295	230	340	275			
Distance ③ (mm)	135	170	200	230	295	230	360	295	435		
Distance ② (mm)	170	170	200	230	295	230	360	295	520	880	
Distance ① (mm)	200	200	200	230	295	475	390	475	520	615	

Q90.195.060

Shelves/number

	Standard storage heights of the shelves			
	4	3		
Distance ④ (mm)	320			
Distance ③ (mm)	350	420		
Distance ② (mm)	350	450		
Distance ① (mm)	290	380		

Q90.195.060

Quantity

Quantity	Storage capacities per drawer/type of container	Type of container	Container size
30		Aerosol cans	400 ml
12		Cans	1 litre
12		Laboratory glass bottles	1 litre
12		Laboratory PE-bottles	1 litre
6		Laboratory glass bottles	2.5 litres

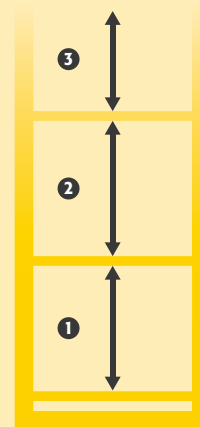



WolfLabs

Pricing on any accessories shown can be found by keying the part number into the search box on our website.

The specifications listed in this brochure are subject to change by the manufacturer and therefore cannot be guaranteed to be correct. If there are aspects of the specification that must be guaranteed, please provide these to our sales team so that details can be confirmed.

www.wolflabs.co.uk

Tel : 01759 301142

Fax : 01759 301143

sales@wolflabs.co.uk

Please contact us if this literature doesn't answer all your questions.